

ALL WOODS ARE BALSA UNLESS OTHERWISE STATED

A 48" SPAN A/I TOWLINE GLIDER  
**La Mouette**  
 Designed by Radoslav Cizek  
 Published by:

**3 MODEL AERONAUTICAL PRESS LTD.**  
 38 Clarendon Road, Watford, Herts.

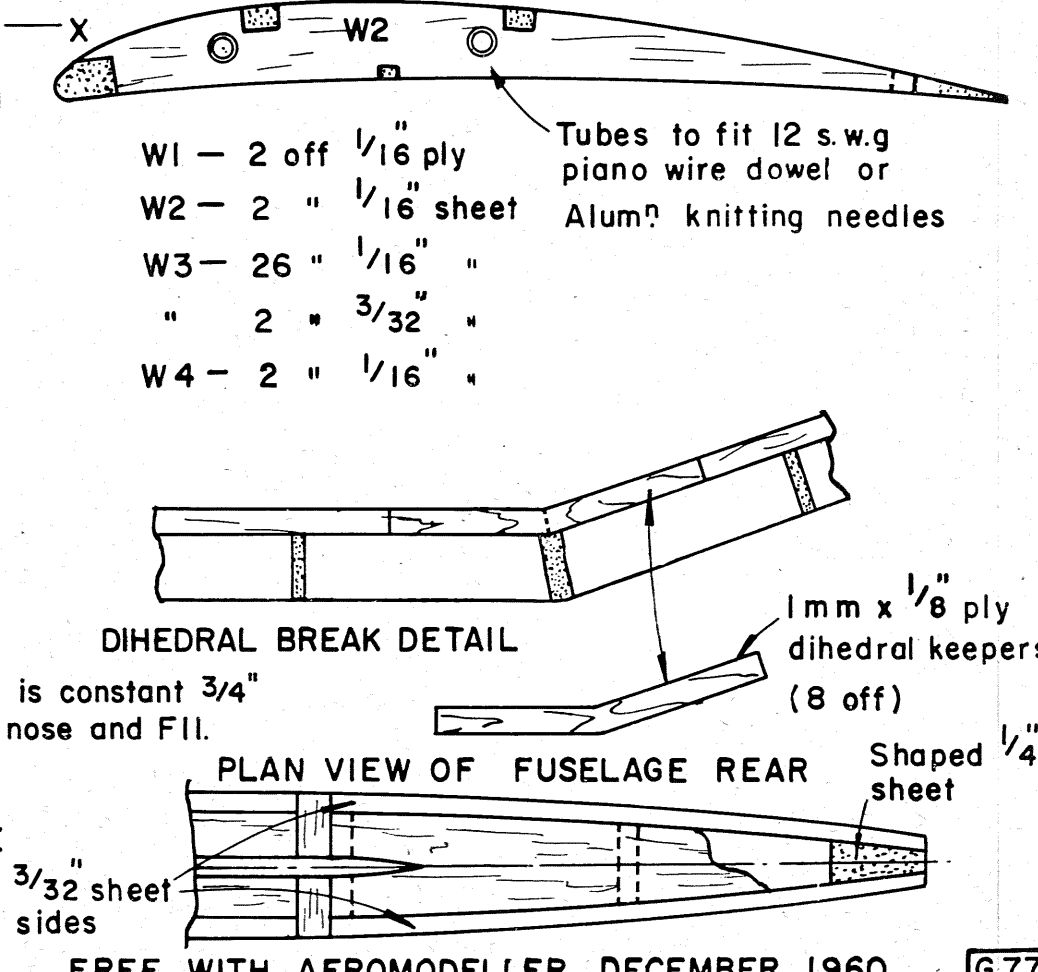
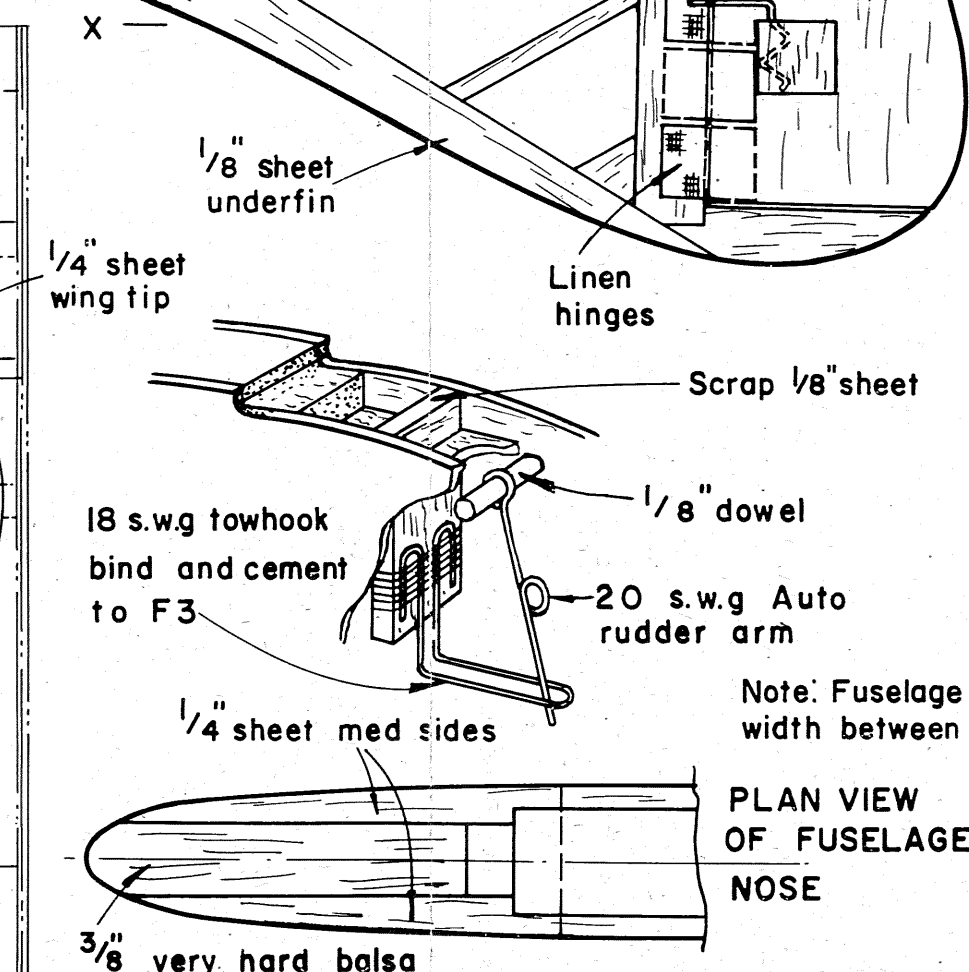
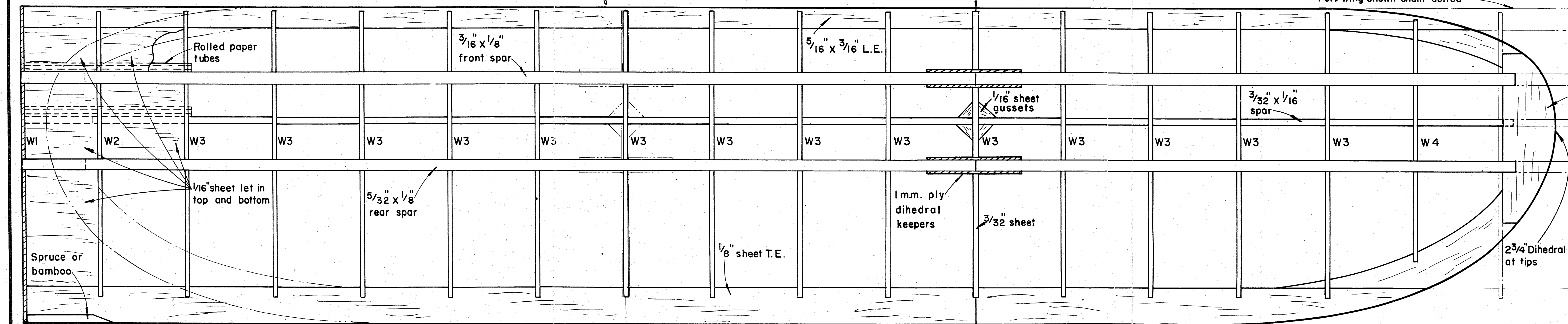
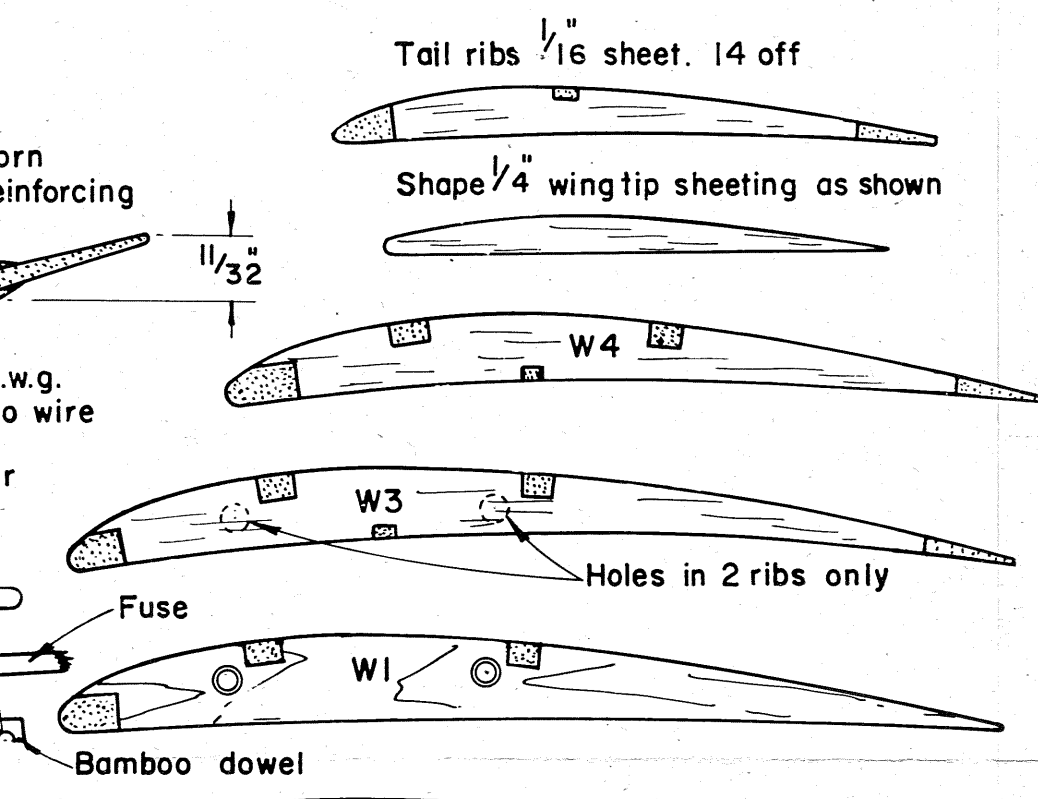
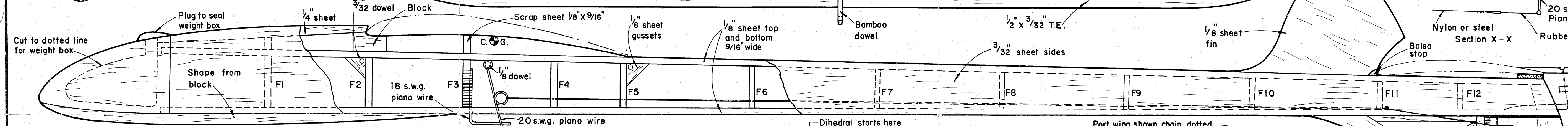
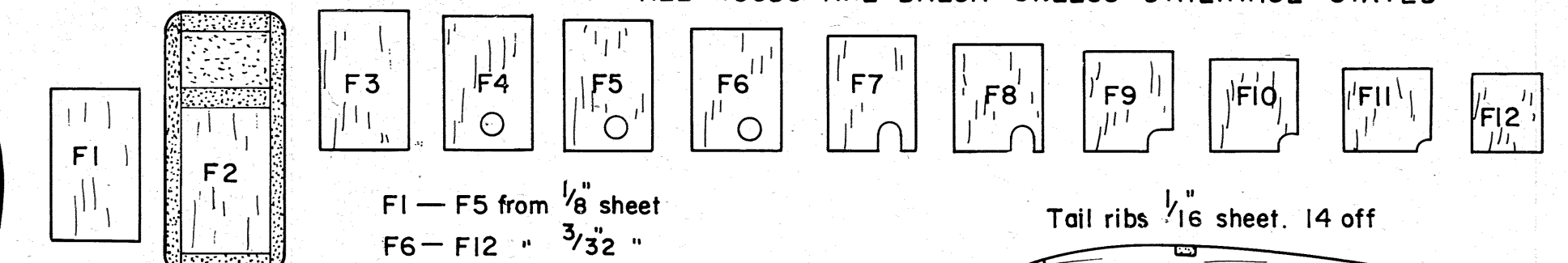
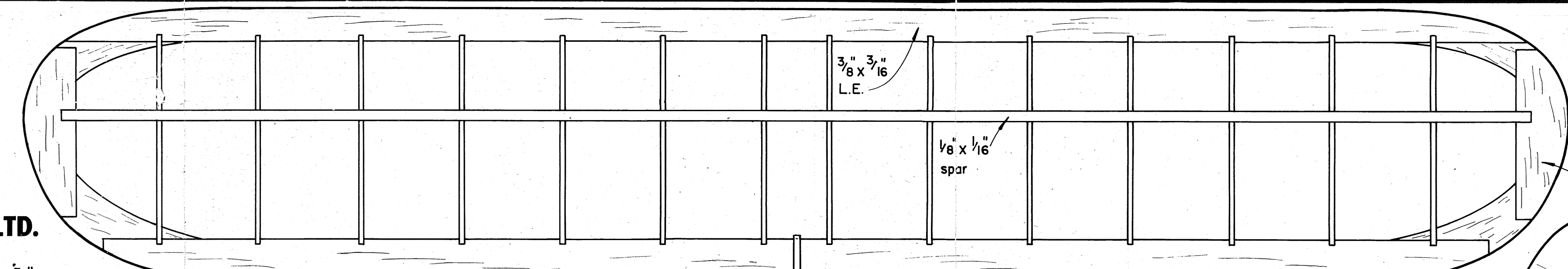

Note: Fuselage is constant 3/4" width between nose and F11.

PLAN VIEW OF FUSELAGE NOSE

PLAN VIEW OF FUSELAGE REAR

3/32 sheet sides